



[www.tokaihit.com](http://www.tokaihit.com)

# Microscope-Stage Automatic Thermocontrol System

Ensures more accurate and more reliable thermal control of the specimens during the observation under a microscope. Wide product range supports Biotechnology Science and Industry.

## *Thermo Plate*<sup>®</sup>



# ThermoPlate®

## Inverted

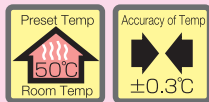

### Controller

The PID control adopted standard for the *ThermoPlate* provides ideal temperature control, and ensures quick startup and high stability against disturbance. The PID control also minimizes overshoot so that accurate and stable temperature control can be ensured at all times.

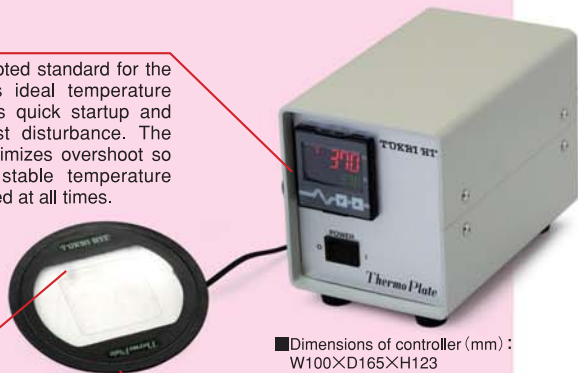

■ Dimensions of controller (mm) :  
W100×D165×H123

### Plate

The *ThermoPlate* utilizes a special transparent heating material coated onto a hard glass. The *ThermoPlate* can be used for observing or manipulating specimen under phase contrast and polarization. The flat plate surface ensures easy operation of the microscopes and relocation of specimen.

### Sensor

A sensor built in the plate ensures excellent heat conductivity between the temperature sensor and the middle part of the plate section, thus minimizing overshoot at power up and temperature fluctuation of the plate surface due to disturbance.

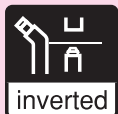

## For Inverted Microscopes



【MATS-U505R30 installed in Nikon:TE300】

Each ThermoPlates are especially designed for various type of microscope stages apertural areas and use of mechanical holders. Depending on magnification of objective and dish type, two plate thickness options are available : 1mm uniform or 0.5 mm at plate center (50×50mm).

### ThermoPlate for insert type :

#### NIKON and OLYMPUS XY-manual stage

MATS-U505R30/U55R30 installed in a microscope stage, the heating plate becomes flush with the stage surface to ensure the easy handling of the specimens and easy operation of manipulator.

#### ThermoPlate for sample holder type : XY-mechanical stage for all manufactures

Since ThermoPlate dimensions are identical with each manufacturer's sample holder, installation is simple and allows you to observe samples with ease using XY mechanical stages.

### 【Main Applications】

Temperature control of the specimen in cell engineering, neuroscience, and genetic engineering, where handling by a manipulator is required.

# ThermoPlate® provides "User

Ensures more accurate and more reliable thermal  
Wide product range supports Biotechnology Science



Applicable Microscopes

Model  
(Glass Thickness)

Ti/TE2000/300/200  
TMD300/200

**MATS-U505R30**  
(0.5mm)

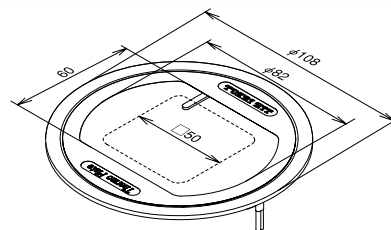

Ti motorized stage

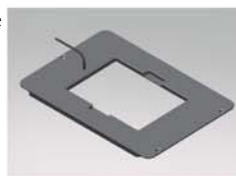

**MATS-UTIDGW**  
(1.0mm)

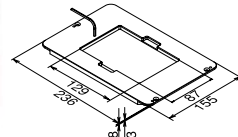

TS100 / TS100-F



**MATS-TS**  
(0.5mm)

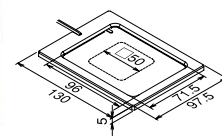

**MATS-CKTS**  
(0.5mm)  
**MATS-CKTSW**  
(1.0mm)

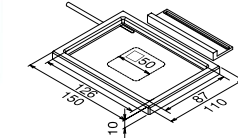

TMS / TMS-F



**MATS-TMS-30**  
(0.5mm)  
**MATS-TMS**  
(1.0mm)

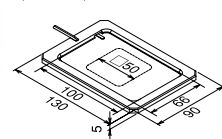

# Comfort" with its High Quality and High Performance.

control of the specimens during the observation under a microscope.  
and Industry.



Applicable Microscopes

Model  
(Glass Thickness)

IX81/71/51  
IX70/50  
IMT2

**MATS-U55R30**  
(0.5mm)

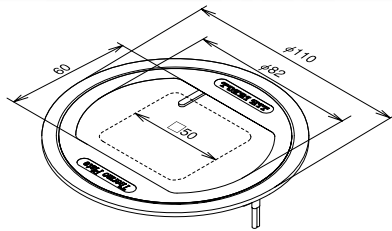

Applicable Microscopes

Model  
(Glass Thickness)

Axio Observer/  
Axiovert series  
(M type frame holder)



**MATS-UAXM-D**  
(0.5mm)  
**MATS-UAXMW-D**  
(1.0mm)

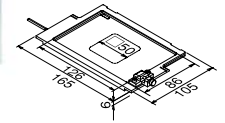

Axio Observer /  
Axiovert series  
(K type frame holder)



**MATS-UAXK-D**  
(0.5mm)  
**MATS-UAXKW-D**  
(1.0mm)

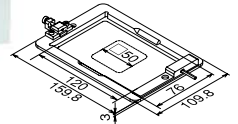

CKX41/31  
CK40/30/2



**MATS-CK2-30**  
(0.5mm)  
**MATS-CK2**  
(1.0mm)

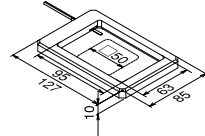

**MATS-CKTS**  
(0.5mm)  
**MATS-CKTSW**  
(1.0mm)

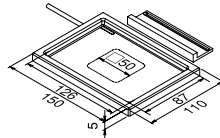

*ThermoPlate* models for Leica microscopes are exclusively distributed through Leica worldwide network the name of "Leica MATS".

Dish Fixing Block for  
MATS - UAXM - D  
MATS - UAXMW - D  
MATS - UAXK - D  
MATS - UAXKW - D



**DFB-3560**

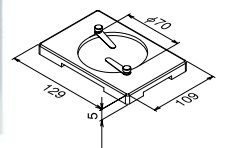

Note:  
Controller is calibrated specifically to make a pair with a plate.  
Multiple plates can not be applied to one controller.

The Process Value displayed on the controller is to demonstrate the temperature of heating plate surface. If the specimen in a petri dish/on a slide glass indicates lower temperature compared to displayed Process Value, adjust Set Value to obtain a proper specimen temperature.

-Dimensional drawings of plate (Outward dimensions, mm)



Applicable Microscopes

Model  
(Glass Thickness)

Prior  
Märzhäuser  
Ludl

**MATS-UAXK-D**  
(0.5mm)  
**MATS-UAXKW-D**  
(1.0mm)

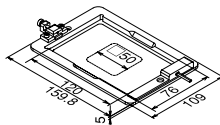

# ThermoPlate®

## Upright

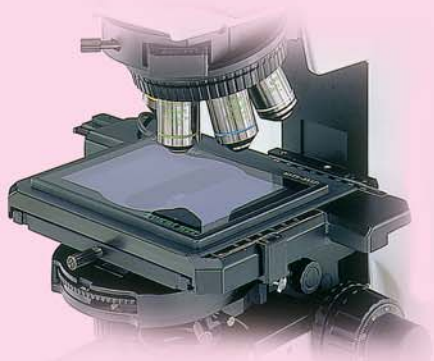
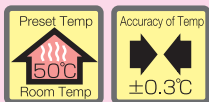

[MATS-U55S installed in OLYMPUS : BX50]



## For Upright Microscopes

MATS-U505S/U55S are universal types, applicable to all upright microscopes of all makes. The plate is to be installed in the mechanical stage and operated to both X-Y directions. Wide and flat plate surface ensures efficient utilization of the whole area of the heating surface and easy handling of specimens. (wide enough to place four slide glasses at the same time or one  $\phi$ 100mm dish.) MATS-U505S/U55S is basically designed for upright microscopes, but also applicable to stereo microscopes.

[Main Applications] Sperm vitality test, ova collections, observation of tissue culture status.

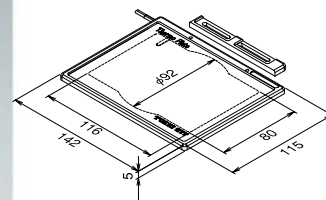

MATS-U505S / U55S



Applicable Microscopes

Model  
(Glass Thickness)

90i/80i/55i/50i/FN1  
E1000/800/600/400/200  
OPTIPHOT-2  
LABOPHOT-2

**MATS-U505S**  
(1.0mm)



Applicable Microscopes

Model  
(Glass Thickness)

POWER BX/BX  
(U-SVLO/SVRO/SVLB-4/SVRB-4)  
BH2  
CX40  
CH40/30

**MATS-U55S**  
(1.0mm)



Applicable Microscopes

Model  
(Glass Thickness)

Axiophot2  
Axioplan2  
Axioskop  
Axiolab  
Axiolab Pol  
Axiolab Imager

**MATS-U55S**  
(1.0mm)



ThermoPlate models for Leica microscopes are exclusively distributed through Leica worldwide network the name of "Leica MATS".

## Stereo

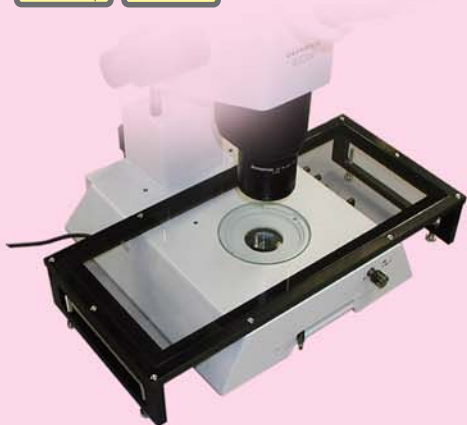
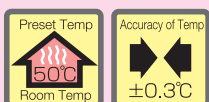

[MATS-U4020WF installed in OLYMPUS : SZX9]

Plate Holding Unit

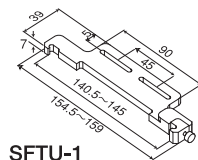

SFTU-1

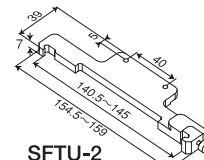

SFTU-2



# For Stereo Microscopes

*ThermoPlate* exclusive models and universal model are available in the range of ThermoPlate for stereo microscopes. *ThermoPlate* exclusive models are designed to match specific microscope stage configuration to provide comfortable environment for users. For the whole surface being heated evenly, the wide working area is secured and multiple specimens may be heated at the same time.



**Nikon**  
MATS-USMZSL installed in Nikon:SMZ1000



**OLYMPUS**  
MATS-SZX2A with SZX2-ILLB      MATS-SZ2 installed in NIKON : SZX7

[Main Application] Ova selections, pre-treatment of ova by means of the IVF technique, warming during manipulation of mice oviduct.

**Nikon** maker      Applicable Microscopes      Model (Glass Thickness)

SMZ1500/1000/800      **MATS-USMZSL** (1.0mm)

SMZ1500/1000/800      **MATS-USMZSS** (1.0mm)

SMZ1500/1000/800      **MATS-USMZR** (1.0mm)

**OLYMPUS** maker      Applicable Microscopes      Model (Glass Thickness)

MXV10  
SZX16/SZX10  
(SZX2-ILLB)  
(SZX2-ILLK)  
(SZX2-ILLD)      **MATS-U55SZX2A** (1.0mm)

SZX16/SZX10  
(SZX2-ILLT)      **MATS-U55SZX2B** (1.0mm)

SZX12/9/7  
(SZX-ILLK)  
(SZX-ILLB2)  
(SZX-ILLD2)      **MATS-SZX** (1.0mm)

**ZEISS** maker      Applicable Microscopes      Model (Glass Thickness)

Stemi 2000 (with large base stand N:495052 9801)      **MATS-UST2** (1.0mm)

Stemi 2000 (with transmitted light base stand:455137)      **MATS-USTR** (1.0mm)

SZX7/SZ61  
(SZ2-ST)  
+  
SZ2-ILA)      **MATS-SZ2** (1.0mm)

**Leica** maker      *ThermoPlate* models for Leica microscopes are exclusively distributed through Leica worldwide network the name of "Leica MATS".

Note:  
Controller is calibrated specifically to make a pair with a plate.  
Multiple plates can not be applied to one controller.

The Process Value displayed on the controller is to demonstrate the temperature of heating plate surface. If the specimen in a petri dish/on a slide glass indicates lower temperature compared to displayed Process Value, adjust Set Value to obtain a proper specimen temperature.

-Dimensional drawings of plate (Outward dimensions, mm)

# ThermoPlate®

## Universal

MATS-U4020WF, universal model, for stereo microscopes, features in the wide clear heated glass area that allows large working space for specimen, and with height adjustable legs, MATS-U4020WF is adaptable to most stereo microscopes of all makes.

Model	Glass Thickness
<b>MATS-U4020WF</b>	1.6mm



Model	Glass Thickness
<b>MATS-UW</b>	1.6mm
	Plate Area : W230×D180×H10 Clear Heating Area : W180×D140×H1.6
<b>MATS-UWL</b>	1.6mm
	Plate Area : W300×D210×H10 Clear Heating Area : W250×D170×H1.6



Note:  
Controller is calibrated specifically to make a pair with a plate.  
Multiple plates can not be applied to one controller.

The Process Value displayed on the controller is to demonstrate the temperature of heating plate surface.  
If the specimen in a petri dish/on a slide glass indicates lower temperature compared to displayed Process Value, adjust Set Value to obtain a proper specimen temperature.  
-Dimensional drawings of plate (Outward dimensions, mm)

## TSU series

Thermometer for Bio-Research

### Thermometer with Super Fine Sensor Probe - 0.25mm diameter

Super-Fine Sensor Probe minimizes heat loss from subject (e.g., specimen). Probe also minimizes influence from ambient for accurate temperature measurement.

#### ■ Digital Thermometer ■ Thermo Probes



**TSU-0125:**  
For K type thermocouple

Display with switchable resolution of 1°C or 0.1°C. With built-in flip-up stand.



**TSU-7225:**  
Telescopic holder type

Telescopic holder-type probe mounted on microscope stage with micro-manipulator bracket enables stable, easy measurement of specimen, etc.



**TSU-25:**  
Stand alone sensor type

Sensor wire is bendable so that sensor can be positioned in various shapes.

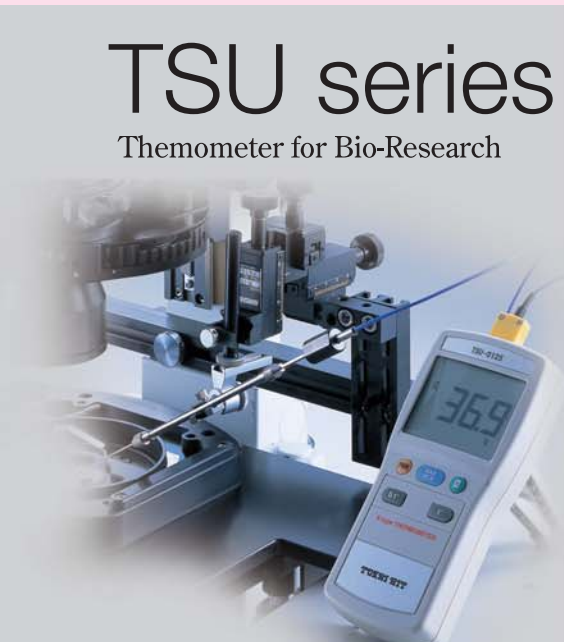

# Are You Still Looking Through a Hole?

**ThermoPlate®**

Please consider *ThermoPlate®* as an optical clear glass heating stage that provides consistent temperature control with no central heat sink.

Tokai Hit carried out a thermographic study on the temperature distribution of the dish contents placed on the ThermoPlate and a plain metal heating stage with a central hole. The results were clear and simple: While *ThermoPlate®* conserves the temperature of dish contents evenly and continuously over time (photos on the left), the metal stage showed unacceptable temperature drop in the dish contents, especially notable at the center, 30°C and lower. (photos on the right)

Because *ThermoPlate®* is a clear heating element, specimen can be heated from directly beneath while being observed under a microscope wherever it is placed.

Is your specimen temperature properly controlled?

*ThermoPlate®* brings not only to you but also to your specimen the most comfortable environment in your laboratory.

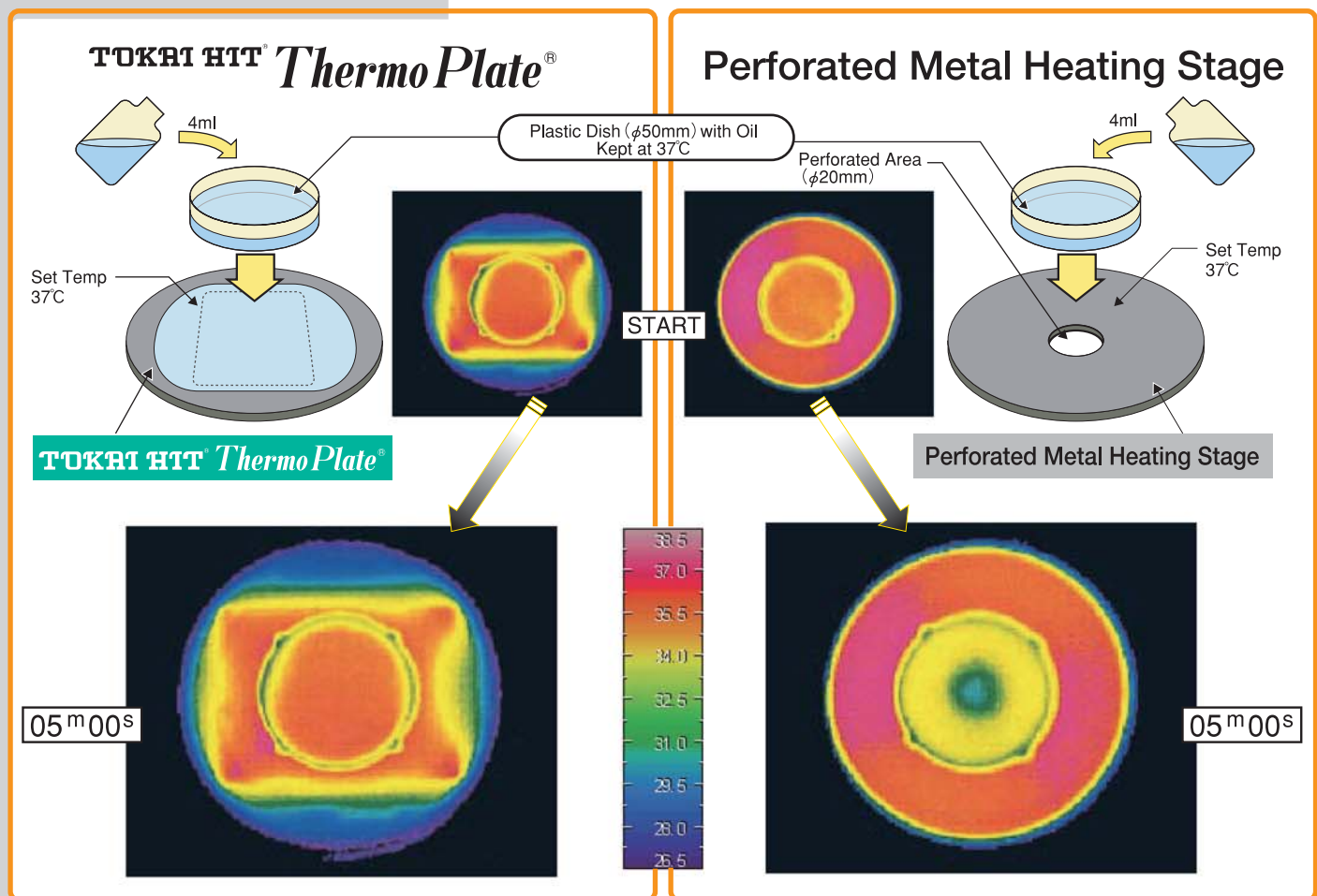

## Comparison of Thermal Distribution

Tokai Hit Clear Glass Heating Plate vs. Metal Perforated Stage Warmer (Internal Comparison)

**ThermoPlate®**

Point A: 36.8°C  
Point B: 37.0°C  
B - A = 0.2°C

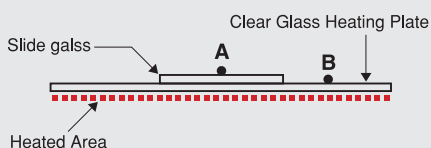

**Perforated Metal Stage Warmer**

Point A: 32.9°C  
Point B: 37.0°C  
B - A = 4.1°C

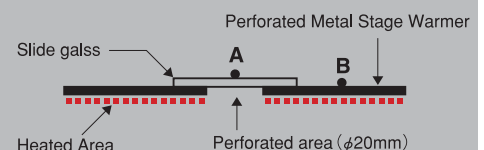

Setting both plate temperature at 37.0°C and placed a slide glass on each plate to compare the temperature of the slide glass center. The room temperature was kept at 25.0°C. (Carried out by Tokai Hit)

<http://www.tokaihit.com>



▲Please pay special attention to items marked with Caution and Warning symbols as seen on the left. It is essential to read the Instruction Manual when using this device.



**TOKAI HIT CO.,LTD.**

306-1 Gendoji-cho, Fujinomiya-shi, Shizuoka-ken, Japan 418-0074  
TELEPHONE:(81)-544-24-6699 FAX:(81)-544-24-6641  
Email:sales-os@tokaihit.com

