



# PathMobile™ Movable Grossing Solutions

Telepathology and Image Archiving for Pathology

PATHMOBILE



Targeted Solutions

# PathMobile™

## Fits your lab

PathMobile is a “roll around” imaging workstation.

### PathMobile Key Features

- 20Mp Image Capture
- 720p Live Preview and Telepathology
- FOV Min 2 cm  
Max 205 cm
- 34X Zoom
- Auto Focus
- Auto Exposure
- 6 Axis Adjustable Camera Arm
- Barcode Auto Login
- One-Click Archive
- One-Click Telepathology Connection
- Autopsy Optimized Interface
- Easy to Clean Design
- Washable Keyboard and Mouse
- Up to 6 hr. Battery Operation Standard

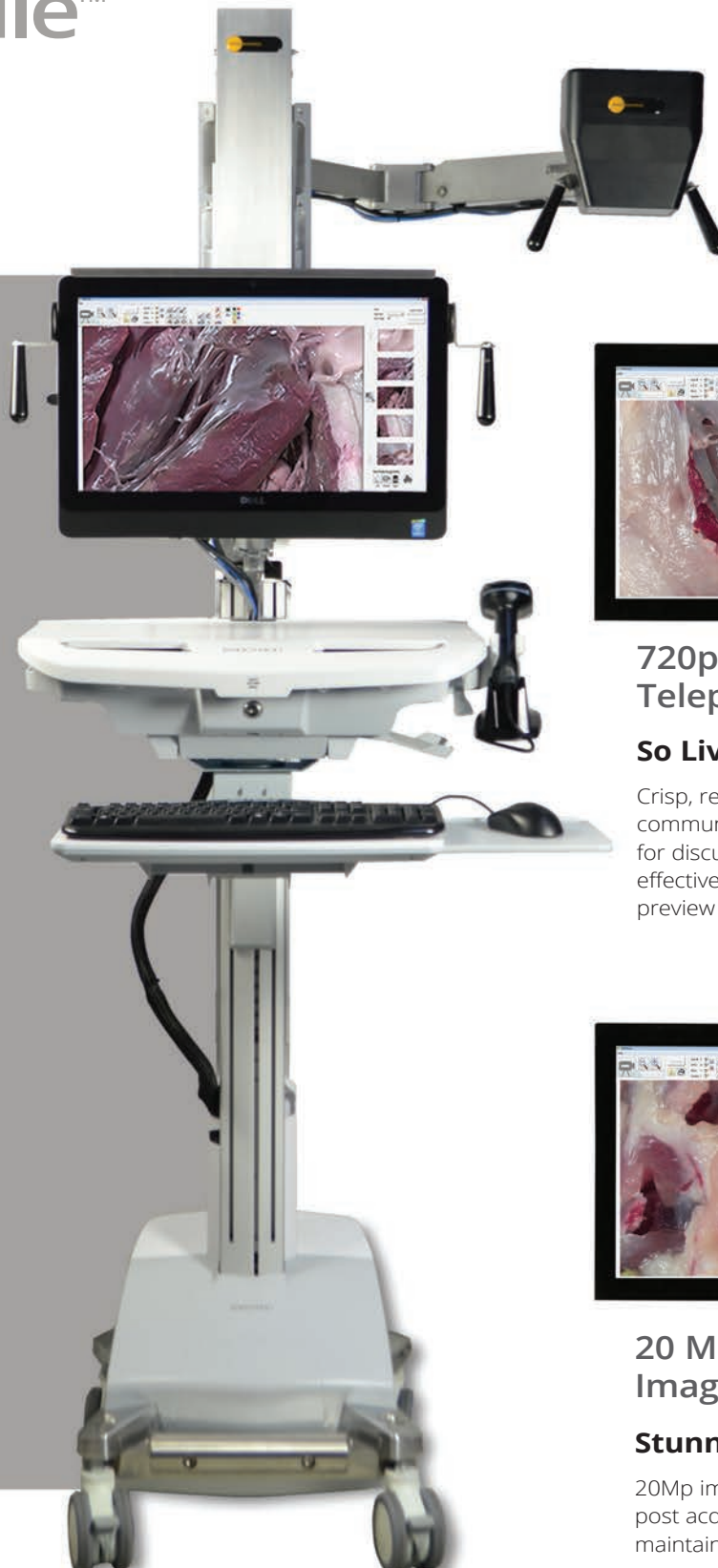

### 720p HD Video Telepathology

#### So Live it Seems Real!

Crisp, real time 720p HD video communicates the smallest details for discussion, ensuring an easy, effective workflow during image preview and telepathology.



### 20 Megapixel Image Capture

#### Stunning Image Detail!

20Mp image capture supports post acquisition cropping while maintaining the resolution necessary for publication. Additionally, the 20Mp image capture easily exceeds the 10Mp resolutions required for legal submissions.



Barcode Gun



Foot Switch

# PathMobile™ Makes it Easy

Fully integrated and completely scalable - integrating cameras, audio, barcode scanners and software.

Our autopsy imaging suite is designed to make professional, legal quality images easy and secure.

## Max FOV



## Max Magnification

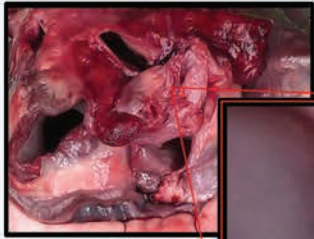

Capture the Details!



2 cm

1.4 cm

Adjustable to fit your viewing needs



6 Axis Adjustable Camera Arm



Washable Keyboard and Mouse

Keep it Clean!



Battery Powered!

Up to 6 hours per Charge

6 hrs.  
5 hrs.  
4 hrs.  
3 hrs.  
2 hrs.  
1 hr.

No Cords Hazards!

# PathMobile™ | Easy to Learn - Easy to Use

PathSuite provides the user with a simple icon driven user interface with one click access to essential controls. This makes PathSuite intuitive to learn and a pleasure to use. PathSuite supports both gross and microscopy imaging with a common user interface.

## Gross Imaging

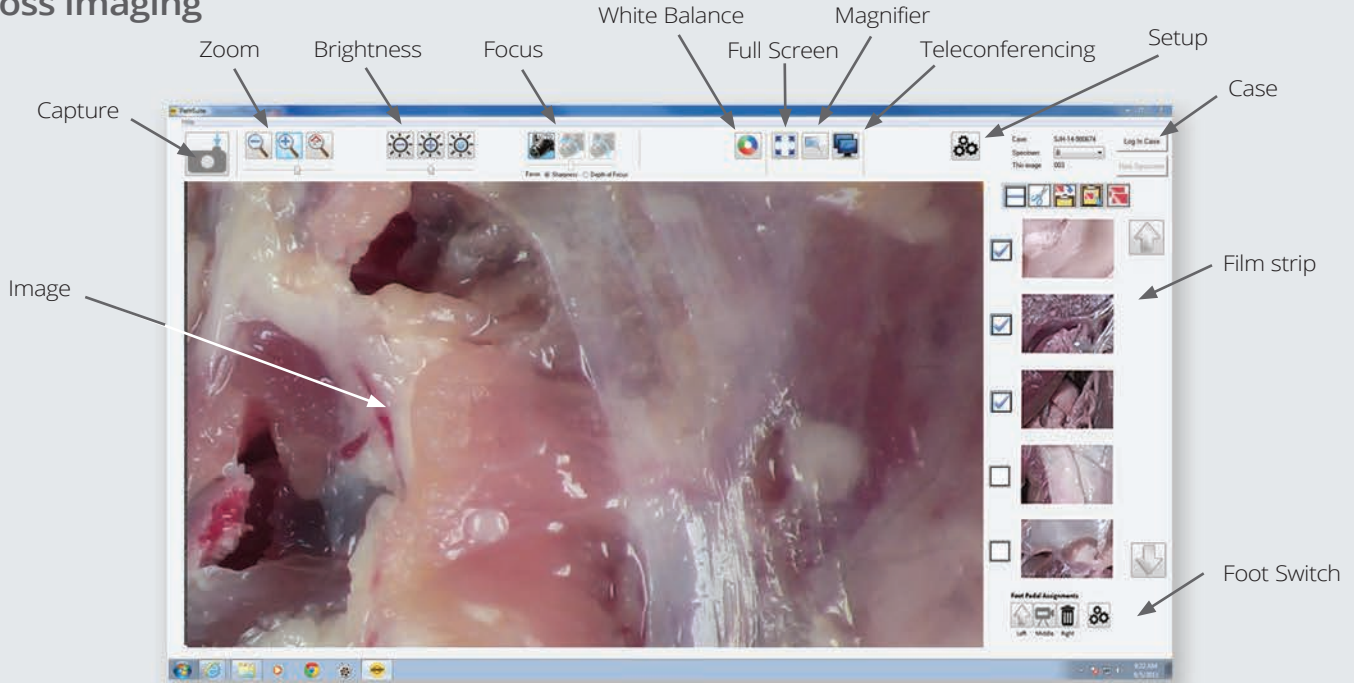

## Streamline Workflow

### Archive

A single click captures and saves images to multiple archive locations, adding annotations as needed.



File server



LIS



Cloud



### Log In

PathSuite provides quick, accurate validation of your image with case Log in.

### Preview

PathSuite makes image composition easy with live preview of your camera adjustments.



# PathMobile™ | Optimized Interface

## Measure, Annotate and Present

PathSuite provides a full suite of annotation and measurement tools for detailing your images without transferring images between programs or computers.



### Auto Imprints

Imprint marks add reference information to your image automatically.

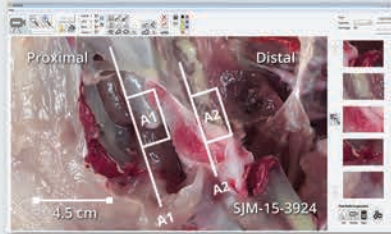

### Custom Annotations

A full set of text and drawing tools ensure fully detailed images.



### Presentation App

PathSuite saves time by facilitating the easy collection, ordering and presentation of your teaching and tumor board images.

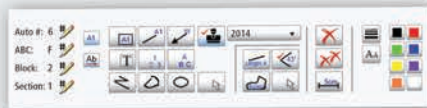

### Style

Annotation style preferences are easily set or changed with control over numbering protocol, font, size, color, fill, etc...

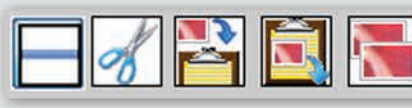

### Case Management Tools

Easily select, duplicate and move images to support your "after hours" and case management work.

## Telepathology

PathSuite provides simple, secure connections and fully interactive live consults in a practical and affordable format.

### Connect



Colleague meetings are initiated by selecting the team member from the connection menu. The colleague receives an invitation prompt on their screen and joins the meeting with a simple click. Non-colleague attendees are easily added to meetings via e-mail invites. Once accepted, meetings are secured using guest passwords and data encryption, supporting HIPPA requirements.

### Routine Consults

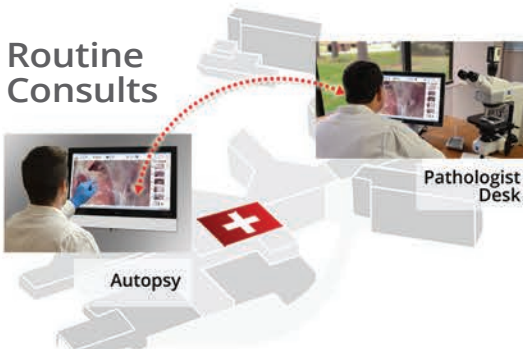

PathSuite ensures a rich collaborative consult allowing colleagues to easily clarify orientation and discuss dissection.

### Document



One Click Image or Video Archive!

PathSuite ensures a rich collaborative consult allowing colleagues to easily clarify orientation, discuss dissection and verify margins.

### Save Time

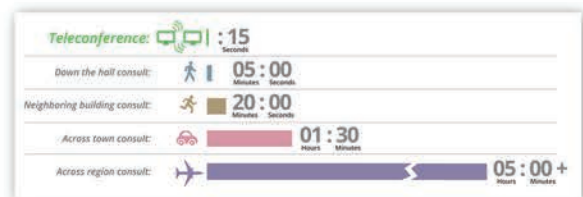

PathSuite telepathology solutions save you time on each trip you make whether it be down the hall, down the street or across the world. It eliminates the time and frustration associated with the trip and the unaccounted for impromptu interactions that occur with each trip. Telepathology lets you connect, consult and return to work without leaving your desk, it's that simple.

## Return on Your Investment

Our install base has garnered dramatic time savings on image acquisition across multiple pathology work tasks resulting in impressively short ROI periods, followed by ongoing savings year after year.



### Routine Gross Dissection

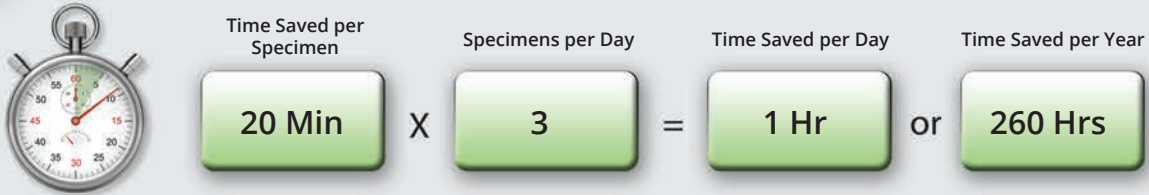

## Increase Consultations

Increasing intraoperative and needle biopsy adequacy consultations provides savings for the organization and the physician by eliminating unreimbursed secondary procedures and increasing patient satisfaction. Pathologists and Pathologist Assistants benefit from the increased efficiency of providing their consults virtually, avoiding the unproductive trip otherwise required.

**Bundled Rate Programs: Planning for Performance-Based Reimbursement**

**Changing Healthcare by Design**

**Performance-Based Bundled Payments: Potential Benefits and Burdens**

**Health Care Reform**

**In the Spotlight: Health Care Reform and Provider Reimbursement**

**Presscott Associates, Ltd.**

## Dimensions

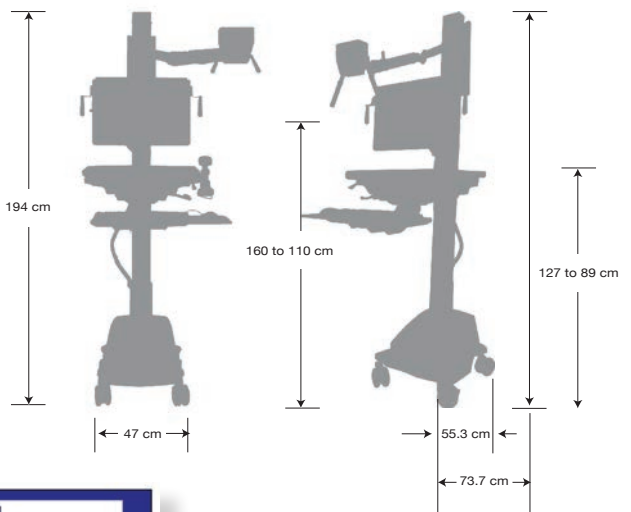

**Presscott Associates, Ltd.**

2012 Fall Managed Care Forum  
November 8-9, 2012

Operationalizing Performance-Based Reimbursement:  
Preparing for Bundled Payment Programs

November 9, 2012

Presented by: David A. Gregory, FACHE

# PathMobile™ | The Smart Choice

## Professional Documentation

Consistent documentation of your work provides the foundation for quality assurance and process improvement. It is also the basis of how you are perceived by your patient families, referring physicians and by the legal establishment.

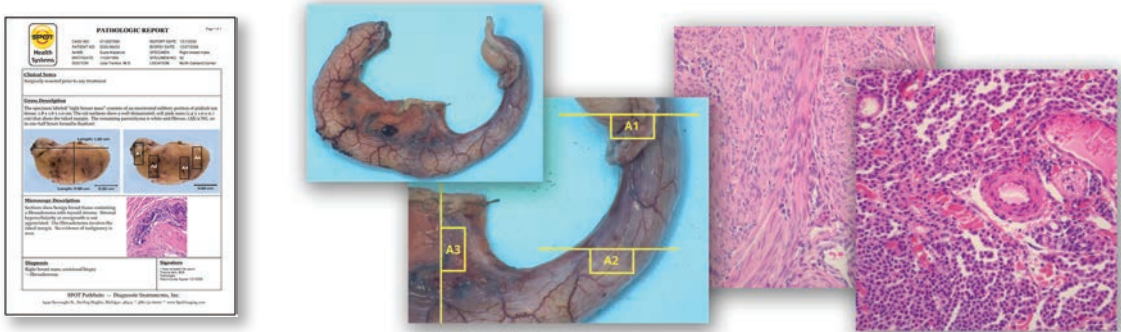

## Easy to Implement

SPOT Imaging Solutions has developed turnkey solutions with configuration options to support your facility's unique hardware and software infrastructure. The result is an optimized work environment that is easily implemented into your existing infrastructure.



"The installation was quick and we were imaging the next day!"

*Satisfied Pathology Assistant,  
Canada*

## We Support You!

You are never alone with PathSuite. InSpect™ technical service. Our 47 year tradition of standing behind our equipment ensures your uptime performance with on-line, on-phone or on-site assistance.



"We had a different system that was sitting in a box because we couldn't use it, PathSuite is so easy to use... Thanks SPOT Imaging!"

*Medical Center, MI*

## Pathology Solutions to Support Your Team

### Microscope Imaging

- Routine Anatomical Pathology
- Frozen Section Consults
- Needle Biopsy Consults
- Tumor Board Presentations
- Teaching and Training

### Macro Imaging

- Routine Gross Dissection
- Frozen Section Consults
- Teaching and Training

# PathMobile™ | Industry Leading Performance

## **Administrators...**

"...the savings we achieve with the PathSuite software makes it a no brainer investment justification. We feel that we are now a state of the art pathology operation..."

*University, NC*

## **User's...**

"So intuitive and easy to use! ... now that we have SPOT, we get our work done quickly and without frustration! It works great!"

*University, GA*

## **IT/Technical Support...**

"...SPOT stands behind their products with on line support, repair services and reliable products ... They've been there for us!"

*Medical Center, PA*

## **Some of our Customer Locations...**

University of Miami	Children's Hospital LA	Appalachian Reg Healthcare System
West Virginia University Hospital	Carillion Canada	Tricore Reference Laboratories
University of Georgia	Central Hospitals of Montreal	Temple University Hospital
Laval University-Eastern Quebec Telepathology	Cedars-Sinai Medical Center	Duke University
Broward Health	Maine Medical Center	Kaiser Hospital
California Pacific Medical Center	The University of Florida	Novant Health
Carolinas HealthCare System	Reading Hospital	Nycom Inc.
Orlando Regional Health Systems	Defense Finance & Acct. Service/DFAS Rome	Virginia Hospital Center
Texas Children's Hospital	Children's Healthcare of Atlanta	University of Pittsburgh Medical Center
Engineering Systems Inc.	Presbyterian Healthcare Services of NM	University of Pennsylvania Health System
Michigan State University	Robert Wood Johnson University Hospital	Alberta Provincial Healthcare

Call SPOT Imaging Solutions for experienced advice on how to dramatically improve your pathology lab with SPOT imaging and telepathology



6540 Burroughs Avenue • Sterling Heights • Michigan 48314-2133 USA  
Toll Free USA: **1-866-604-SPOT** • Phone: **+1 586-731-6000** • Fax: **+1 586-731-6469**  
Web: **www.spotimaging.com**