



# Grossing Solutions

Telepathology and Image Archiving for Pathology



# PathStation™ | Fits Your Lab

**PathStation hood** Compact In-hood Imaging system. Supports in-process documentation



## PathStation Key Features

- 20 MP Image Capture
- Great HD Video
- 8.33X Optical zoom  
4X Digital zoom
- 34" x 28" Max FoV
- 0.50" x 0.38" Min FoV
- Auto Calibration
- Small Package
- Supports Your Workstation
- Foot Pedal Camera Control
- Auto Focus
- Auto Exposure
- Bar Code Auto Login
- One-Click Archive
- One-Click Telepathology Connection
- Pathology Optimized Interface
- Easy Clean Design
- Washable Keyboard and Mouse

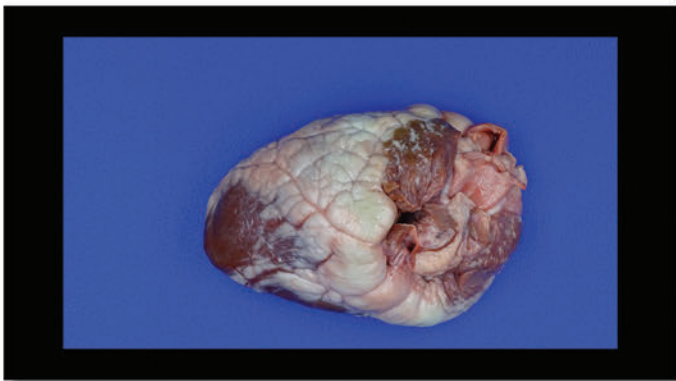

## 720p HD Video Telepathology

### So Live it Seems Real!

Crisp, real time 720p HD video communicates the smallest details for discussion, ensuring an easy, effective workflow during image preview and telepathology.

## 20 Megapixel Image Capture

### Stunning Image Detail!

20Mp image capture supports post acquisition cropping while maintaining the resolution necessary for publication. Additionally, the 20 Mp image capture easily exceeds the 10 Mp resolutions required for legal submissions.



# PathStation™ | Makes it Easy

Fully integrated and completely scalable - integrating cameras, audio, barcode scanners and software. Our pathology imaging suite is designed to empower you from scanning to case sign-out.

## Compact!

G2 Camera

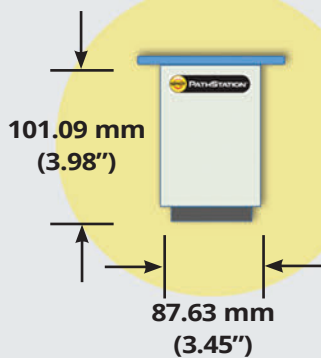

G20 Camera

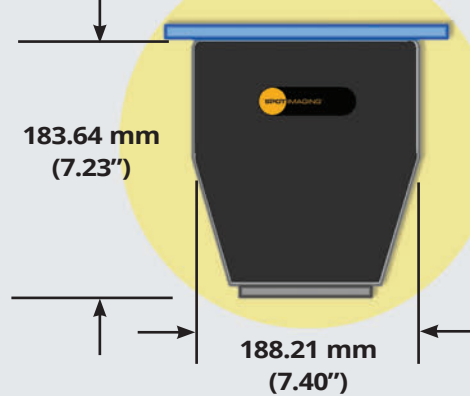

## Optical Zoom

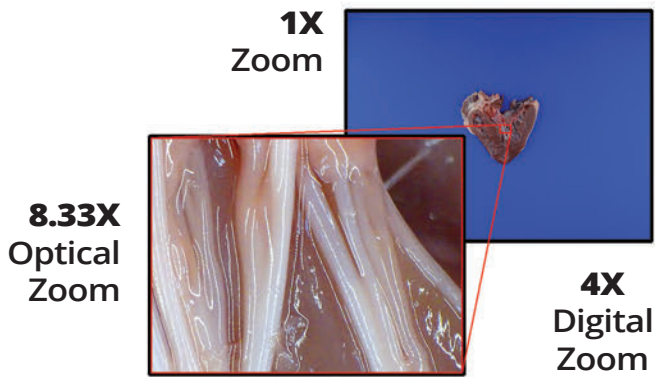

## Hands Free Imaging



## Automated Workflow Saves Time!

- Barcode Auto Login
- Auto Exposure
- Auto Focus
- Auto Archiving

## High Resolution Touch Screen



## Washable Keyboard and Mouse



# PathStation™ | Easy to Learn - Easy to Use

PathSuite provides the user with a simple icon driven user interface with one click access to essential controls. This makes PathSuite intuitive to learn and a pleasure to use. PathSuite supports both gross and microscopy imaging with a common user interface.

## Gross Imaging

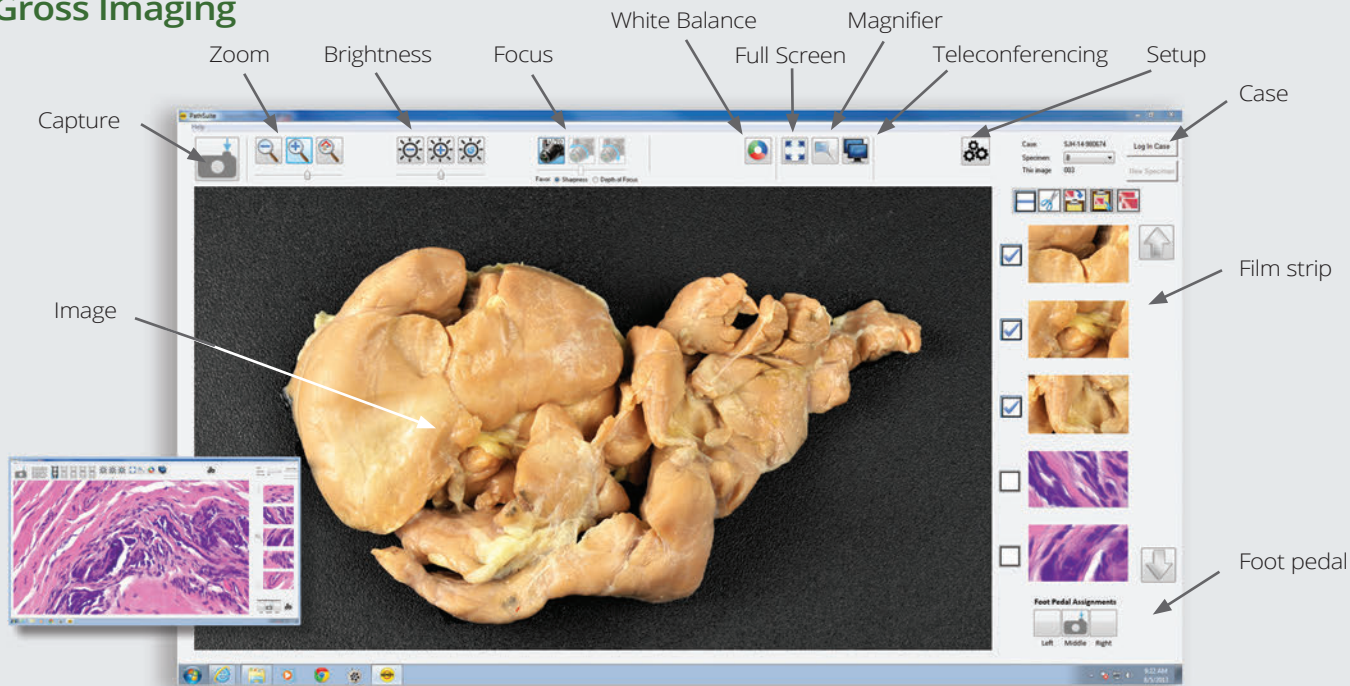

## Streamline Workflow

**3 Archive**  
A single click captures and saves images to multiple archive locations, adding annotations as needed.

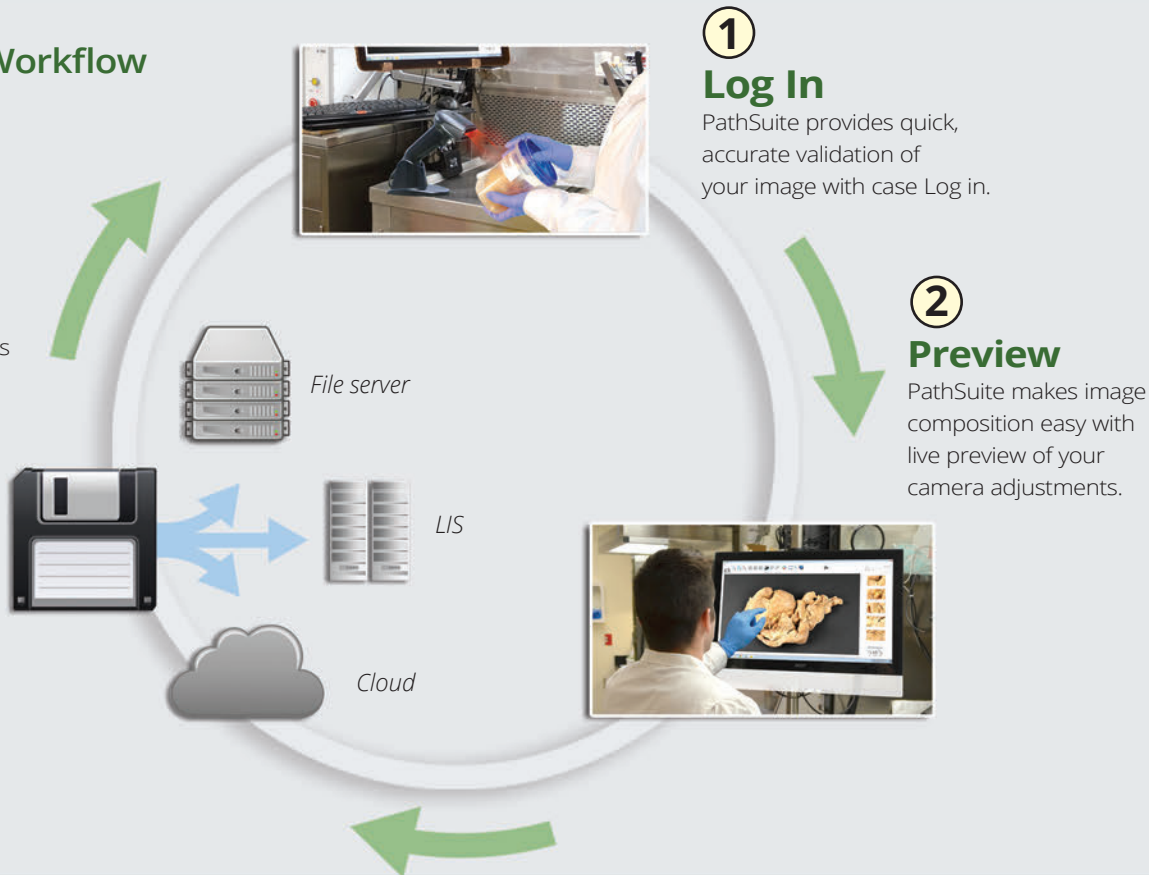

**1 Log In**  
PathSuite provides quick, accurate validation of your image with case Log in.

**2 Preview**  
PathSuite makes image composition easy with live preview of your camera adjustments.

# PathStation™ | Optimized Interface

## Measurement and Annotate

PathSuite provides a full suite of annotation and measurement tools for detailing your images without transferring images between programs or computers.



### Auto Imprints

Imprint marks add a dimensional reference to your image.

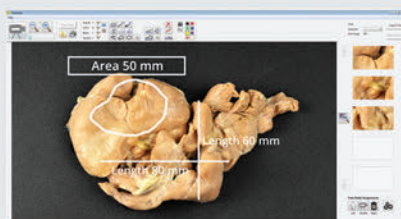

### Measurement

PathSuite's pre-calibrated images allow for easy measurement of length, area & angle.



### Custom Annotations

A full set of text and drawing tools ensure you have the arrow text or oval to quickly and fully detail your images for consultation, publication or standard reporting.



### Style

Annotation style preferences are easily set or changed with control over numbering protocol, font, size, color, fill, etc...

## Telepathology

PathSuite provides simple, secure connections and fully interactive live consults in a practical and affordable format.

### Connect



Colleague meetings are initiated by selecting the team member from the connection menu. The colleague receives an invitation prompt on their screen and joins the meeting with a simple click. Non-colleague attendees are easily added to meetings via e-mail invites. Once accepted, meetings are secured using guest passwords and data encryption, supporting HIPPA requirements.

### Document



PathSuite ensures a rich collaborative consult allowing colleagues to easily clarify orientation, discuss dissection and verify margins.

### Consult

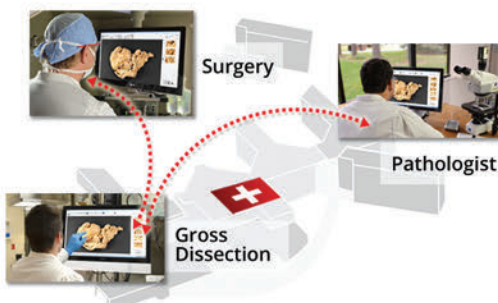

Discussion images are easily saved to the case with a click of a button preserving results for later reference and follow up.

### Save Time

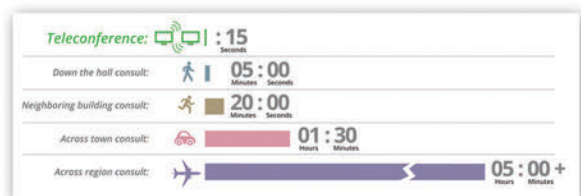

PathSuite telepathology solutions save you time on each trip you make whether it be down the hall, down the street or across the world. It eliminates the time and frustration associated with the trip and the unaccounted for impromptu interactions that occur with each trip. Telepathology lets you connect, consult and return to work without leaving your desk, it's that simple.

## Return on Your Investment

Our install base has garnered dramatic time savings on image acquisition across multiple pathology work tasks resulting in impressively short ROI periods, followed by ongoing savings year after year.



### Routine Gross Dissection



Time Saved per Specimen **10 Min** × Specimens per Day **12** = Time Saved per Day **2 Hrs** or Time Saved per Year **520 Hrs**

## Increase Consultations

Increasing intraoperative and needle biopsy adequacy consultations provides savings for the organization and the physician by eliminating unreimbursed secondary procedures and increasing patient satisfaction. Pathologists and Pathologist Assistants benefit from the increased efficiency of providing their consults virtually, avoiding the unproductive trip otherwise required.

## Professional Documentation

Consistent documentation of your work provides the foundation for quality assurance and process improvement. It is also the basis of how you are perceived by your patients, referring physicians and by the legal establishment.

### Bundled Rate Programs: Planning for Performance-Based Reimbursement

Hill Prossman, FACHE  
President  
Presscott Associates, a division of Pathnet

David Plog  
Senior Vice President, Strategic Planning  
HealthQuest

President of the  
**American College of Healthcare Executives**  
Dr. John W. Lee

### Changing Healthcare by Design

Health care reform is special report

### Performance-Based Bundled Payments: Potential Benefits and Burdens

Richard L. Berry, MD, and Judith Weiss

### In the Spotlight: Health Care Reform and Provider Reimbursement

The Affordable Care Act (ACA) aims to improve health care delivery in many ways, from access to quality to cost. Providers are being asked to make changes, to have enhanced efficiency, to share the financial risk, and additional costs will be affected. This paper will dig in to the ways that reimbursement will change for providers. Reimbursement is the payment for services performed, that health care providers receive from payers, their state health plans and public insurance programs. Changing the reimbursement structure for providers has the potential to alter the way health care operates. Most of the program reforms began in 2011 and 2012, however, the changes will continue through 2018. The ACA alters the ways that providers are reimbursed from government insurance programs, as specified below. These reimbursement changes will help also influence the reimbursement methods of private insurers over the long term, as well. The ACA includes:

- Prospective Accountable Care Organization (ACO) Model: ACOs will no longer be reimbursed for services rendered to patients that are assigned to a hospital (2012)
- Changes in plan for Home Health and Ambulatory Surgical Center Value-Based Purchasing for Medicare (2015)
- Public Health Value-Based Payment Model: "Value-Based Payment" For Schedule adjustment reimbursement to be based on quality and cost of care (2012)
- Performance Incentive and Disincentive Program for Medicare Advantage Plans: Use the relative percentage of the Medicare Advantage plan's quality performance, so the high-performing plans will be rewarded (in 4-10 year 2012)
- Payments based on performance quality measures for Medicare hospitals beginning in October for Medicare (2012)
- Adjustments of Medicare hospital payments to encourage hospitals to undertake reforms that meet health care performance measurement beginning in October (2012)
- Hospital Value-Based Purchasing Program: Inclusion of Efficiency Measures for Medicare will include efficiency measures as which have been awarded (2012)
- Diagnostic/Screening Shared Hospital payment program to reimburse hospitals for care for untreated will be not in 20 percent (2014)
- Value-Based Payment Model for Medicare Physician Fee Schedule (application in 2011, all physicians and general practice in 2012)
- Payments to hospitals with high rates of hospital-acquired infections will be reduced beginning in October in Medicare (2014)
- Pay for Performance for Select Medicare Providers: payment incentives for providers who meet certain quality and efficiency goals (2012)

These program reforms will have reimbursement affects across the industry on payment issues, as well as operations.

**What to expect:**  
Changing the way providers are reimbursed certainly has implications beyond the Medicare, Medicaid, and CHIP programs. Cuts to the Diagnostic/Screening Shared Hospital program, as well as the public insurance programs, may result in some cost shifting to private medical insurance. Clearly, this is not the result that supporters of program reform hope to have. ACA's goal is to create a measure of payment reforms, in which private insurance companies

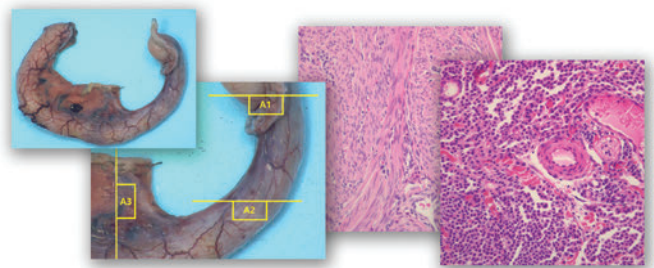
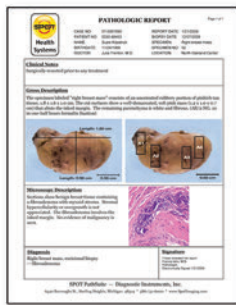

Presscott Associates, Ltd.

2012 Fall Managed Care Forum  
November 8-9, 2012

Operationalizing Performance-Based Reimbursement:  
Preparing for Bundled Payment Programs

November 9, 2012

Presented by: David A. Gregory, FACHE

© 2012 Presscott Associates, Ltd.  
11400 Valley View Road, Suite 100  
Houston, TX 77037

# PathStation™ | The Smart Choice

## Easy to Implement

SPOT Imaging Solutions has developed turnkey solutions with configuration options to support your facility's unique hardware and software infrastructure. The result is an optimized work environment that is easily implemented into your existing infrastructure.



"The installation was quick and we were imaging the next day!"

*Satisfied Pathology Assistant,  
Canada*

## We Support You!

You are never alone with PathSuite. InSpect™ technical service. Our 47 year tradition of standing behind our equipment ensures your uptime performance with on-line, on-phone or on-site assistance.



"We had a different system that was sitting in a box because we couldn't use it, PathSuite is so easy to use... Thanks SPOT Imaging!"

*Medical Center, MI*

## Pathology Solutions to Support Your Team

### Microscope Imaging

- Routine Anatomical Pathology
- Frozen Section Consults
- Needle Biopsy Consults
- Tumor Board Presentations
- Teaching and Training

### Macro Imaging

- Routine Gross Dissection
- Frozen Section Consults
- Teaching and Training

#### G2 Dimensions

##### Camera Head

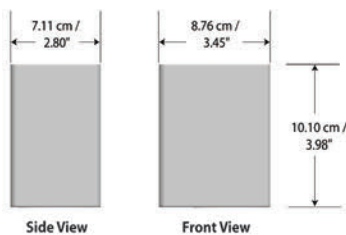

#### G20 Dimensions

##### Camera Head

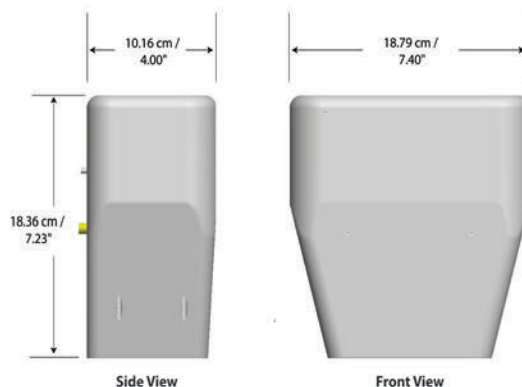

##### Control Box

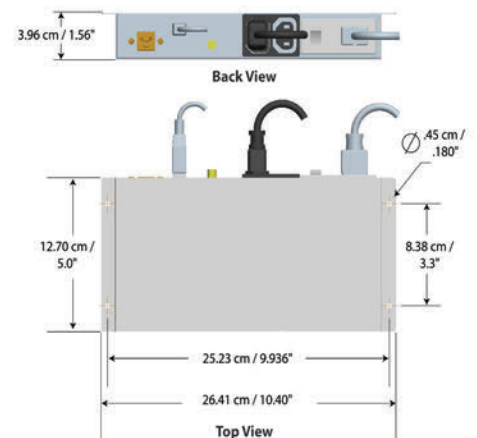

# PathStation™ | Industry Leading Performance

## Administrators...

"...the savings we achieve with the PathSuite software makes it a no brainer investment justification. We feel that we are now a state of the art pathology operation..."

*University, NC*

## User's...

"So intuitive and easy to use! ... now that we have SPOT, we get our work done quickly and without frustration! It works great!"

*University, GA*

## IT/Technical Support...

"...SPOT stands behind their products with on line support, repair services and reliable products ... They've been there for us!"

*Medical Center, PA*

## Some of our Customer Locations...

University of Miami	Children's Hospital LA	Appalachian Reg Healthcare System
West Virginia University Hospital	Carillion Canada	Tricore Reference Laboratories
University of Georgia	Central Hospitals of Montreal	Temple University Hospital
Laval University-Eastern Quebec Telepathology	Cedars-Sinai Medical Center	Duke University
Broward Health	Maine Medical Center	Kaiser Hospital
California Pacific Medical Center	The University of Florida	Novant Health
Carolinas HealthCare System	Reading Hospital	Nycom Inc.
Orlando Regional Health Systems	Defense Finance & Acct. Service/DFAS Rome	Virginia Hospital Center
Texas Children's Hospital	Children's Healthcare of Atlanta	University of Pittsburgh Medical Center
Engineering Systems Inc.	Presbyterian Healthcare Services of NM	University of Pennsylvania Health System
Michigan State University	Robert Wood Johnson University Hospital	Alberta Provincial Healthcare

Call SPOT Imaging Solutions for experienced advice on how to dramatically improve your pathology lab with SPOT imaging and telepathology

